

REVISIONS			
LTR	DESCRIPTION	DATE	APPROVED
A	NEW DRAWING	12/01	

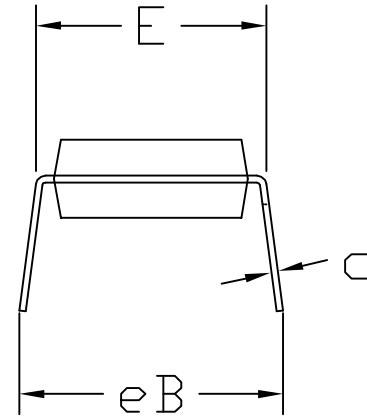
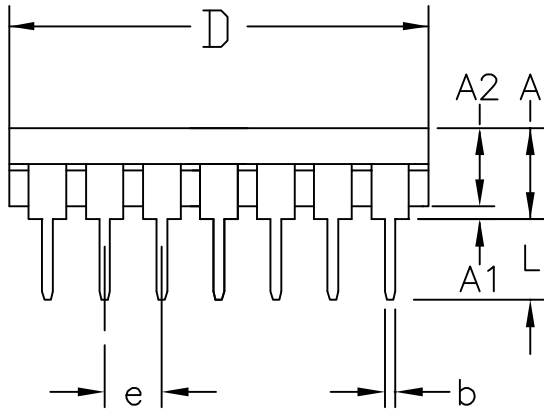
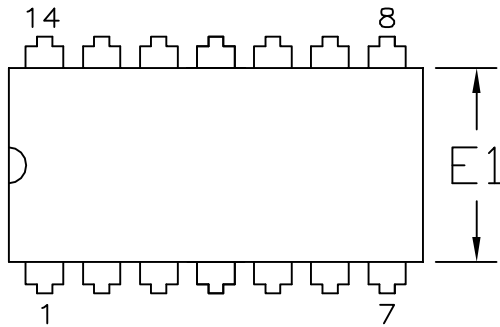

	14 PIN	
	MIN	MAX
A	—	0.170
A1	0.015	—
A2	0.115	0.195
b	0.015	0.022
c	0.008	0.012
D	0.745	0.755
E	0.300	0.325
E1	0.240	0.260
e	0.090	0.110
L	0.125	0.135
eB	—	0.430

ALL DIMENSIONS ARE IN INCHES

SIGNATURE		DATE				
DOC. CONTROL:						
ENGR. MGR:						
MFG. ENGR:						
CHECKED BY: TWM		12/01	TITLE MARKETING OUTLINE, 14 LEAD PLASTIC DUAL-IN-LINE PACKAGE (0.300")			
DRAWN BY: JFD		12/01	SIZE A	FSCM NO	PART NO. 56-G5005-001	REV A
DO NOT SCALE DWG.			SCALE N/A		SHEET 1 OF 1	